

Manometr puszkowy różnicowy

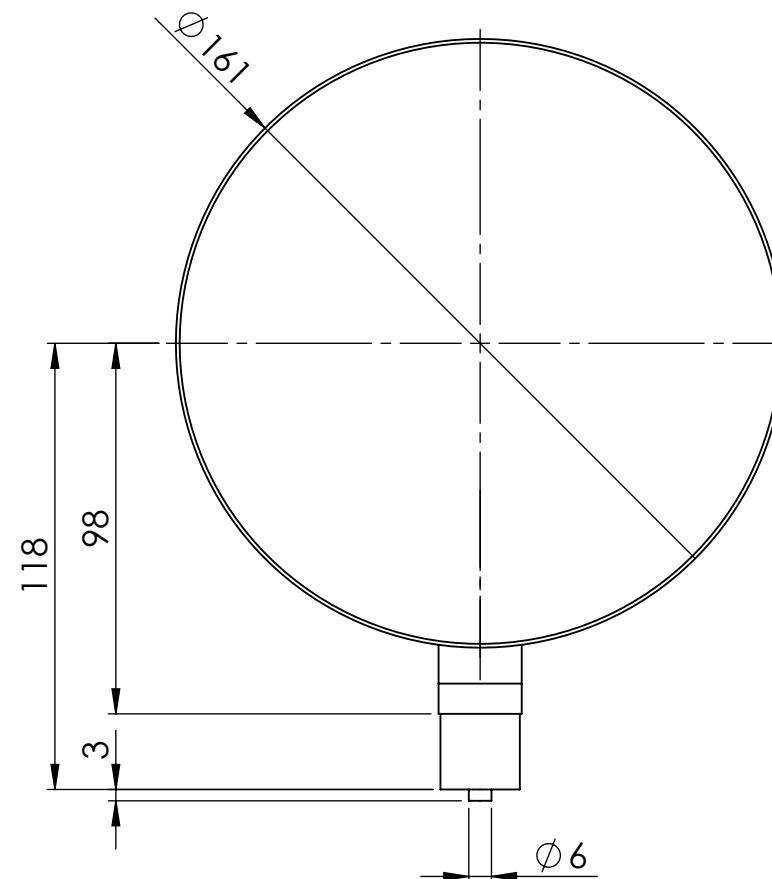
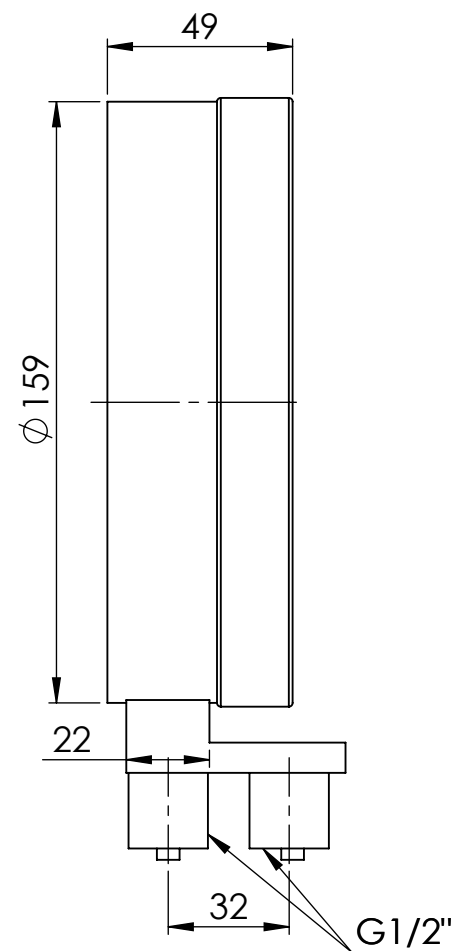

Opis rysunku			
Manometr puszkowy KP 160 Dif, D401, fi160 mm, 0÷40 mbar, G1/2", rad, kl. 1,6			
Skala	Data	Numer katalogowy	Rev.
1:1	15.12.2022	35 617 401	0
Jednostka [mm]	Data rewizji		
	15.12.2022	AFRISO Sp. z o. o. Szalsza, ul. Kościelna 7, 42-677 Czekanów tel. (32) 330-33-55 www.afriso.pl e-mail: zok@afriso.pl	
AFRISO			