

Manometr puszkowy

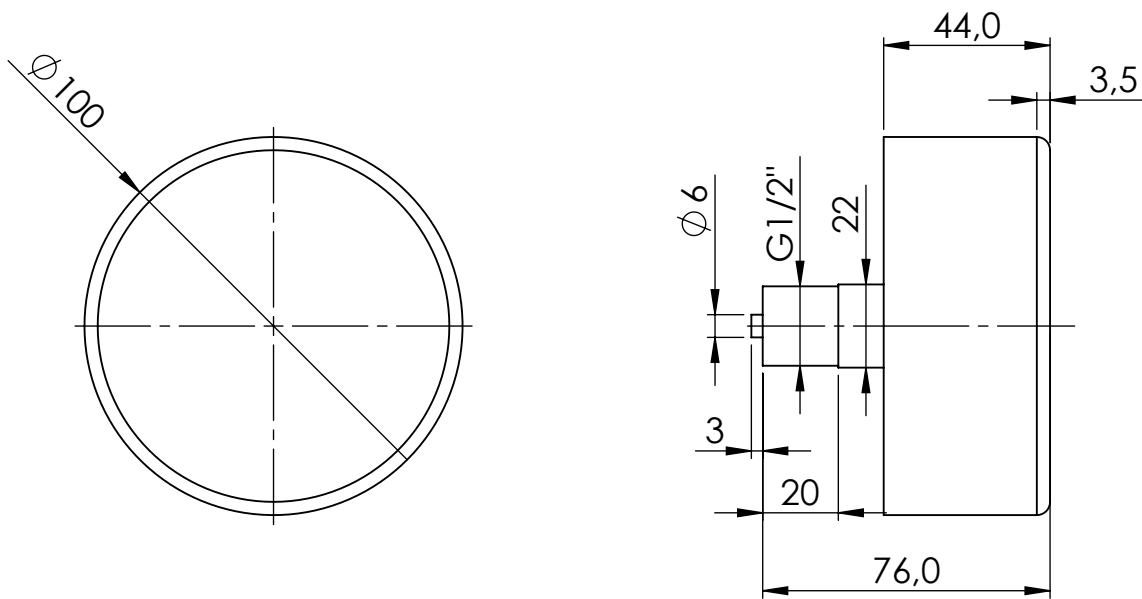

Opis rysunku

Manometr puszkowy KP 100, D211, fi100 mm, 0÷60 mbar, G1/2", ax, kl. 1,6

Skala 1:1	Data 14.12.2022	Numer katalogowy 35 118 211	Rev. 0
Jednostka [mm]	Data rewizji 14.12.2022		



AFRISO Sp. z o. o. Szalsza, ul. Kościelna 7, 42-677 Czekanów
tel. (32) 330-33-55 www.afriso.pl e-mail: zok@afriso.pl