

Operating instructions



Solar pump assembly

PrimoSol® 130

Type: 130-1

Type: 130-4

Copyright 2019 AFRISO-EURO-INDEX GmbH. All rights reserved.



1 About these operating instructions

These operating instructions describe the solar pump assembly "PrimoSol® 130" (also referred to as "product" in these operating instructions). These operating instructions are part of the product.

- You may only use the product if you have fully read and understood these operating instructions.
- Verify that these operating instructions are always accessible for any type of work performed on or with the product.
- Pass these operating instructions as well as all other product-related documents on to all owners of the product.
- If you feel that these operating instructions contain errors, inconsistencies, ambiguities or other issues, contact the manufacturer prior to using the product.

These operating instructions are protected by copyright and may only be used as provided for by the corresponding copyright legislation. We reserve the right to modifications.

The manufacturer shall not be liable in any form whatsoever for direct or consequential damage resulting from failure to observe these operating instructions or from failure to comply with directives, regulations and standards and any other statutory requirements applicable at the installation site of the product.

2 Information on safety

2.1 Safety messages and hazard categories

These operating instructions contain safety messages to alert you to potential hazards and risks. In addition to the instructions provided in these operating instructions, you must comply with all directives, standards and safety regulations applicable at the installation site of the product. Verify that you are familiar with all directives, standards and safety regulations and ensure compliance with them prior to using the product.

Safety messages in these operating instructions are highlighted with warning symbols and warning words. Depending on the severity of a hazard, the safety messages are classified according to different hazard categories.



DANGER

DANGER indicates a hazardous situation, which, if not avoided, will result in death or serious injury.



WARNING

WARNING indicates a potentially hazardous situation, which, if not avoided, can result in serious injury or equipment damage.

NOTICE

NOTICE indicates a hazardous situation, which, if not avoided, can result in equipment damage.

In addition, the following symbols are used in these operating instructions:



This is the general safety alert symbol. It alerts to injury hazards or equipment damage. Comply with all safety instructions in conjunction with this symbol to help avoid possible death, injury or equipment damage.



This symbol alerts to hazardous electrical voltage. If this symbol is used in a safety message, there is a hazard of electric shock.

2.2 Intended use

This product may only be used to circulate the following liquids in intrinsically safe, sealed, solar systems:

- Standard heat transfer fluids (solar liquids) suitable for solar systems such as water-glycol mixtures

The integrated safety group assembly serves to secure against excessive pressure.

Any use other than the application explicitly permitted in these operating instructions is not permitted and causes hazards.

Verify that the product is suitable for the application planned by you prior to using the product. In doing so, take into account at least the following:

- All directives, standards and safety regulations applicable at the installation site of the product
- All conditions and data specified for the product
- The conditions of the planned application

In addition, perform a risk assessment in view of the planned application, according to an approved risk assessment method, and implement the appropriate safety measures, based on the results of the risk assessment. Take into account the consequences of installing or integrating the product into a system or a plant.

When using the product, perform all work and all other activities in conjunction with the product in compliance with the conditions specified in the operating instructions and on the nameplate, as well as with all directives, standards and safety regulations applicable at the installation site of the product.

2.3 Predictable incorrect application

The product must never be used in the following cases and for the following purposes:

- Operation with swimming pool water
- Use with adherent, corrosive or flammable fluids
- Temperatures and pressures in excess of or below the permissible temperatures and pressures

2.4 Qualification of personnel

Only appropriately trained persons who are familiar with and understand the contents of these operating instructions and all other pertinent product documentation are authorized to work on and with this product.

These persons must have sufficient technical training, knowledge and experience and be able to foresee and detect potential hazards that may be caused by using the product.

All persons working on and with the product must be fully familiar with all directives, standards and safety regulations that must be observed for performing such work.

2.5 Personal protective equipment

Always wear the required personal protective equipment. When performing work on and with the product, take into account that hazards may be present at the installation site which do not directly result from the product itself.

2.6 Modifications to the product

Only perform work on and with the product which is explicitly described in these operating instructions. Do not make any modifications to the product which are not described in these operating instructions.

3 Transport and storage

The product may be damaged as a result of improper transport or storage.

NOTICE

DAMAGE TO THE PRODUCT

- Verify compliance with the specified ambient conditions during transport or storage of the product.
- Use the original packaging when transporting the product.
- Store the product in a clean and dry environment.
- Verify that the product is protected against shocks and impact during transport and storage.

Failure to follow these instructions can result in equipment damage.

4 Product description

4.1 Overview

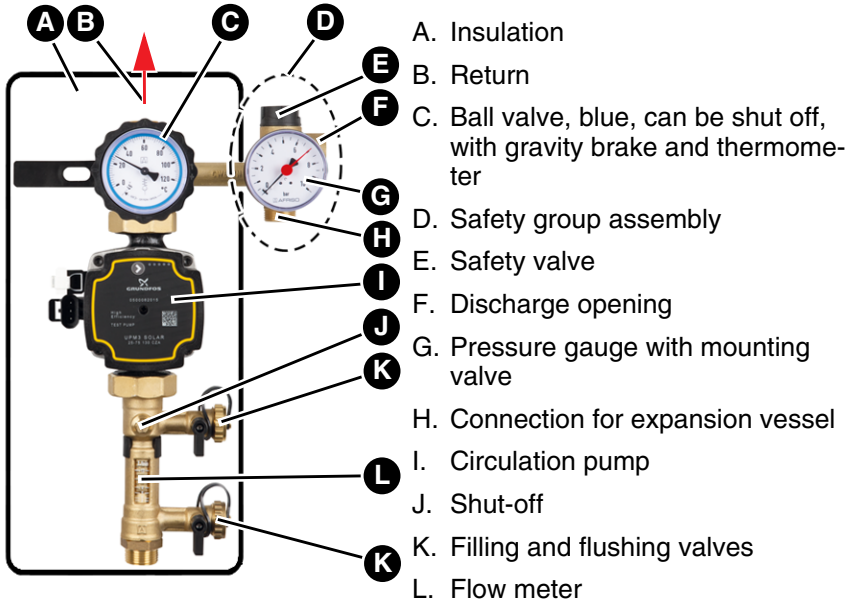

Fig. 1: PrimoSol@ 130-1, pump line

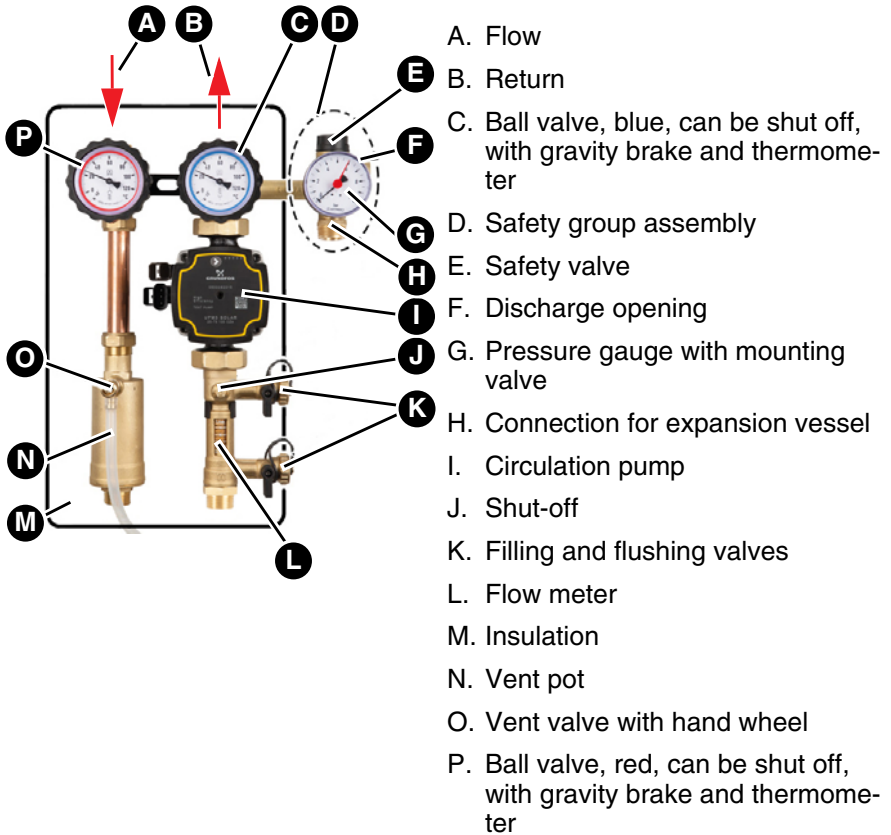

Fig. 2: PrimoSol@ 130-4, flow and return with filling and flushing valves and vent pot

4.2 Dimensions

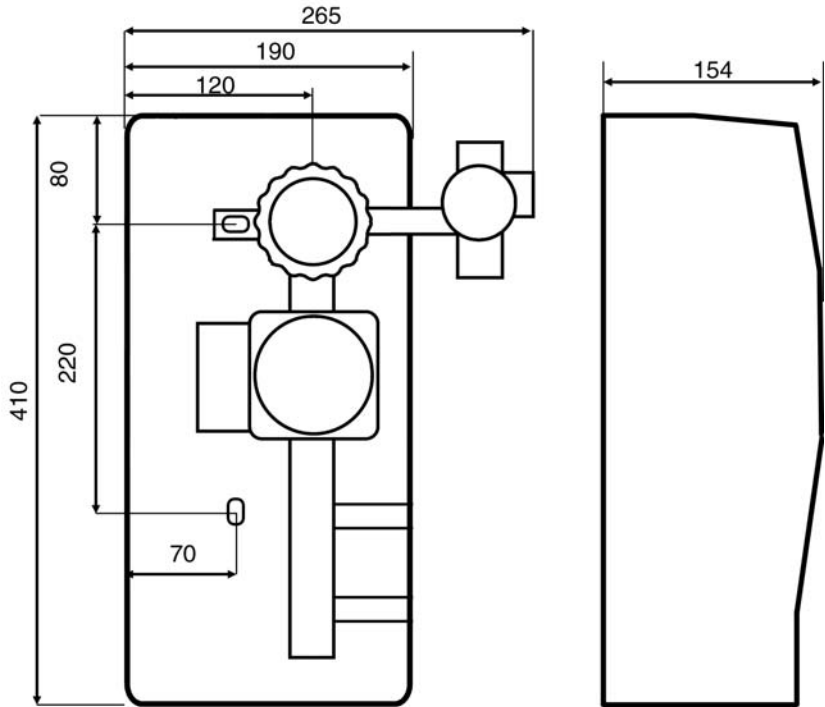

Fig. 3: PrimoSol® 130-1 (in mm)

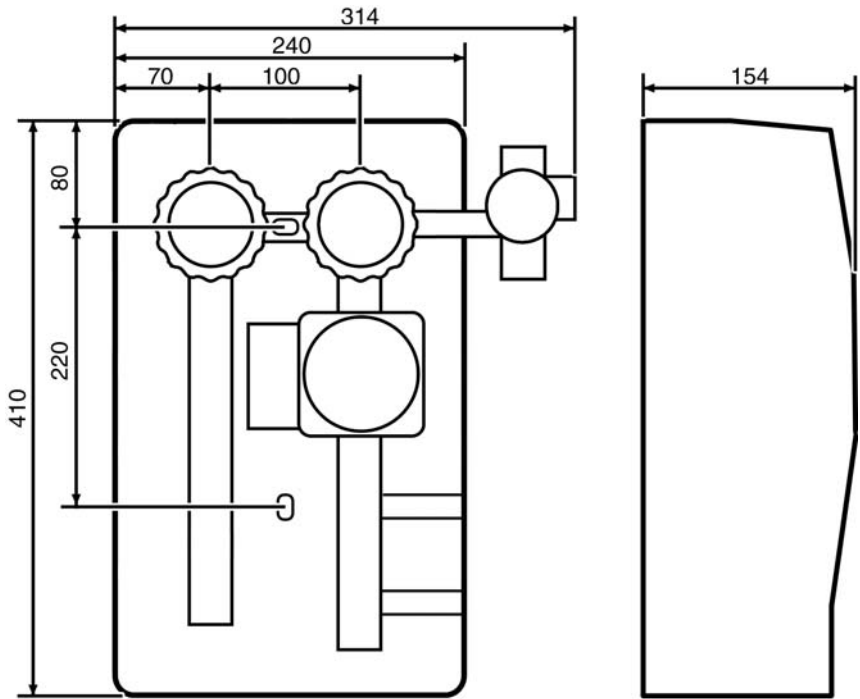

Fig. 4: PrimoSol@ 130-4 (in mm)

4.3 Function

Complete, pre-assembled and tightness-tested solar pump assembly with all required safety and functional components, including form-fit insulation. The insulation is also used to package the product for safe transport.

A comprehensive range of accessories is available for all solar pump assembly, (see chapter "Spare parts and accessories").

4.4 Approvals, conformities, certifications

The safety valve of the safety group assembly complies with the Pressure Equipment Directive (2014/68/EC).

See operating instructions of the manufacturer of the circulation pump for versions with circulation pump.

4.5 Technical specifications

Parameter	Value
General specifications	
System connection	G ³ / ₄
Weight	Max. 5.5 kg
Material of fittings	Brass CW617N
Insulation material	Polypropylene EPP
System pressure	Max. 6 bar
Type of sealing	Flat-sealing
Operating temperature range	
Ambient	Max. 40 °C
Medium	Max. 120 °C, short-term max. 160 °C
Flow meter	
Pump connection	Pump side with flange and union nut G1 ¹ / ₂
Measuring range	2-12 l/min, 8-28 l/min, 8-38 l/min
Combination valve red (flow)	
Range	0/+120 °C
Combination valve blue (return)	
Pump connection	Pump side with flange and union nut G1 ¹ / ₂
Range	0/+120 °C
Safety group assembly	
Connection for expansion vessel	G ³ / ₄ for flex pipe, flat-sealing with union nut
Safety valve	6 bar
Pressure gauges	Ø 63 mm, 0-10 bar

5 Mounting



WARNING

BURNS CAUSED BY HOT LIQUID

The liquid in solar systems is under high pressure and can have temperatures of more than 100 °C.

- Verify that the liquid has cooled down before opening the system.

Failure to follow these instructions can result in death, serious injury or equipment damage.

- ⇒ Install the solar pump assembly in such a way that no steam can get into the expansion vessel during stagnation.
- ⇒ If the expansion vessel is mounted at the same height as the solar pump assembly or higher than the solar pump assembly, install a heat trap siphon.
- ⇒ Verify that liquid can escape via the discharge line of the safety valve during heating up.
- ⇒ Verify that the product cannot be shut off.
- ⇒ Verify that no shut-off elements, filters or similar equipment is installed.
- ⇒ Verify that the product is mounted in such a way that no external forces can act on the components after it has been installed.
- ⇒ Verify that the product is not overheated by welding or soldering work performed on the system.
 - Install the product after completion of such welding or soldering work.
- ⇒ Verify that the nominal pressure of the product corresponds to the specification value of the system.
- ⇒ Verify that the liquid in the system and the application area of the product are compatible.
- ⇒ Verify that the pipes are thoroughly flushed prior to installation of the product.
 - Impurities such as weld beads, hemp or metal chips cause leaks of the safety valve and the check valves.

5.1 Mounting the product

- ⇒ Check the sealing surfaces for cleanliness and damage.
- ⇒ Verify that all pipe ends are perpendicular and have been deburred.

The product is delivered ready to be installed. You must not dismount any of the parts.

1. Remove the upper insulation.
2. Hold the product to the wall with the lower insulation, align it with a level and draw two marks.
3. Drill a hole (\varnothing 10 mm) at each of the marked positions and insert the enclosed dowels.
4. Screw the long hanger bolt into the top hole, the short hanger bolt into the bottom hole.
5. Fit the product with the bottom insulation and secure it with a washer and a nut.
6. Connect the pipes of the solar circuit to the connections of the fittings (see chapter "Connecting the product").
7. Fit the upper insulation.

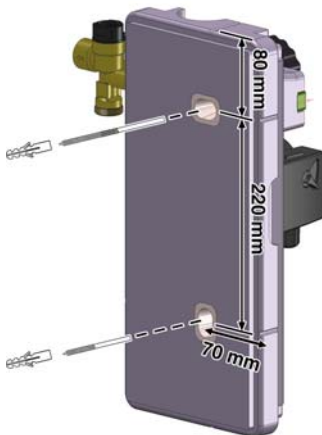
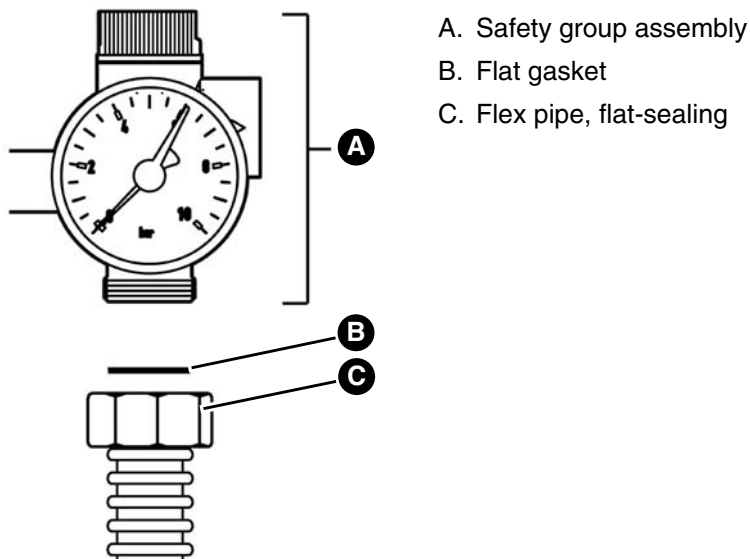

Fig. 5: PrimoSol@ 130-1 (left)



Fig. 6: PrimoSol@ 130-4 (right)

5.2 Connecting the product



- A. Safety group assembly
- B. Flat gasket
- C. Flex pipe, flat-sealing

Fig. 7: Fig. : Connection flex pipe $G^{3/4}$

1. Connect the pipes of the solar circuit to the connections of the fittings.
2. Connect the pipe or flex pipe of the expansion vessel to the safety group assembly. The connection kits for the expansion vessel are available as accessories (see chapter "Spare parts and accessories").
3. Connect the discharge line to the safety valve to the safety group assembly (see chapter "Mounting the discharge line of the safety valve").
4. Connect the circulation pump (see chapter "Electrical connection").

5.3 Mounting the discharge line of the safety valve



WARNING

BURNS CAUSED BY HOT LIQUID

The liquid in solar systems is under high pressure and can have temperatures of more than 100 °C.

- Verify that the liquid has cooled down before opening the system.
- Install the discharge line in such a way as to avoid any damage or injuries due to escaping liquid.

Failure to follow these instructions can result in death, serious injury or equipment damage.

- ⇒ Verify that the discharge line is accessible and easy to oversee.
 - ⇒ Verify that the liquid discharged via the discharge line is drained into a tank (collector tank for solar liquid from AFRISO) that can hold the total capacity of the system. The collected liquid must be returned to the system or disposed of by a specialised company. Do not drain the discharged liquid into the sewage system.
1. The discharge line must have a gradient; its cross section must have at least the same cross section as that of the discharge opening.
 - The length of the discharge line must not exceed 2 m; the maximum number of elbows is 2.



The discharge opening is designated by an arrow on the valve body.

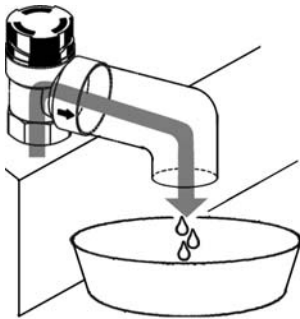

Fig. 8: Discharge line with tank (left)

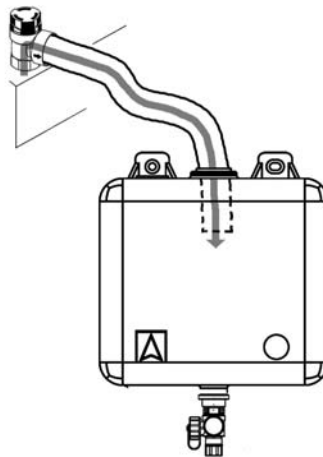

Fig. 9: Discharge line with collector tank for solar liquid from AFRISO (right)

5.4 Electrical connection



DANGER

ELECTRIC SHOCK

- Verify that the degree of protection against electric shock (protection class, double insulation) is not reduced by the type of electrical installation.

Failure to follow these instructions will result in death or serious injury.



DANGER

ELECTRIC SHOCK CAUSED BY LIVE PARTS

- Disconnect the mains voltage supply before performing the work and ensure that it cannot be switched on.
- Verify that no hazards can be caused by electrically conductive objects or media.

Failure to follow these instructions will result in death or serious injury.

NOTICE

DAMAGE TO THE PUMP ELECTRONICS

- Verify that the pump is not controlled via an external speed controller which changes the supply voltage.
- Verify that the pump is controlled with 230 V without phase angle control.
- Switch the pump on and off via the controller.

Failure to follow these instructions can result in equipment damage.

1. Connect the circulation pump in accordance with the enclosed instructions.
2. Route the connection cable of the circulation pump through the cable duct to the bottom and connect it to the solar controller. Observe the operating instructions of the solar controller.

Shielded cable 3 x 1.5 mm² and up to Ø 10 mm can be used to extend the connection cable.

6 Commissioning

6.1 Commissioning the product

PrimoSol® 130-4 is filled via the filling and flushing valves at the flow meter.

PrimoSol® 130-1 is filled via an external filling and flushing unit.

1. Attach a label in the vicinity of the discharge line or to the safety valve with the following text:
"For safety reasons, liquid must be able to escape via the discharge line during heating. Do not shut off!"
2. Verify that all connections are tight.
3. Set both ball valves to 45 ° position.



0 ° operation

- Open in direction of flow of solar liquid

45 ° commissioning, filling, venting, flushing:

- both ends open (backflow preventer not active)

90 ° maintenance

- closed

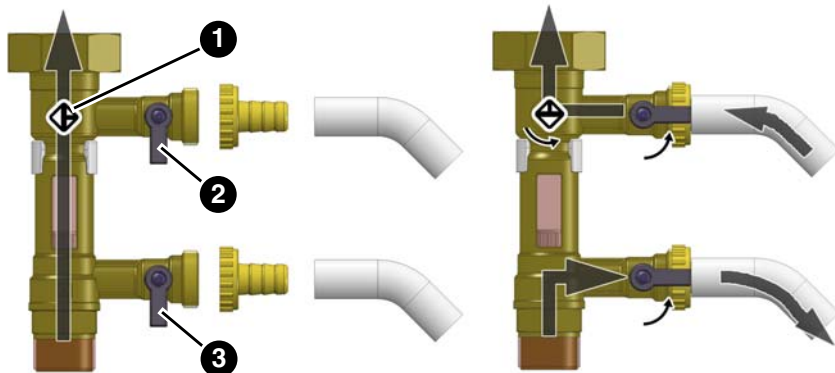

4. Screw hose connectors to the filling and flushing valves.
5. Connect the hoses.

6. Open the two shut-off valves (2, 3) and close the shut-off (1) for filling.
7. Fill the system with solar liquid via the shut-off valve (2).
8. As soon as solar liquid escapes via the lower shut-off valve (3), close this shut-off valve.
9. Apply pressure to the system.
10. Close the upper shut-off valve (2).
11. Turn the shut-off (1) back.
12. Vent the system (see chapter "Venting the system").
13. Set the two ball valves to 0° position.
14. Fit the upper part of the insulation onto the fitting group.
15. Make sure the pipe insulation reaches into the corresponding recess of the insulation of the product.

7 Operation

For safety reasons, liquid must escape via the discharge line of the safety valve during heating.

1. Do not shut off the safety valve.
2. If the safety valve has triggered, check the system before recommissioning the system.

⇒ Proper operation is only possible if the ball valves are open (0 °).

7.1 Reading mark at flow meter

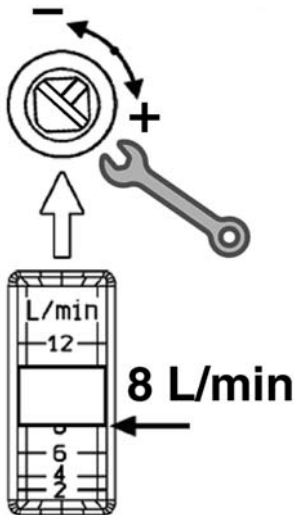

The lower edge of the float is the reading mark at the flow meter.

7.2 Venting the system



WARNING

BURNS CAUSED BY HOT LIQUID

The liquid in solar systems is under high pressure and can have temperatures of more than 100 °C.

- Verify that the liquid has cooled down (< 50 °C at the red thermometer) before venting the system.

Failure to follow these instructions can result in death, serious injury or equipment damage.

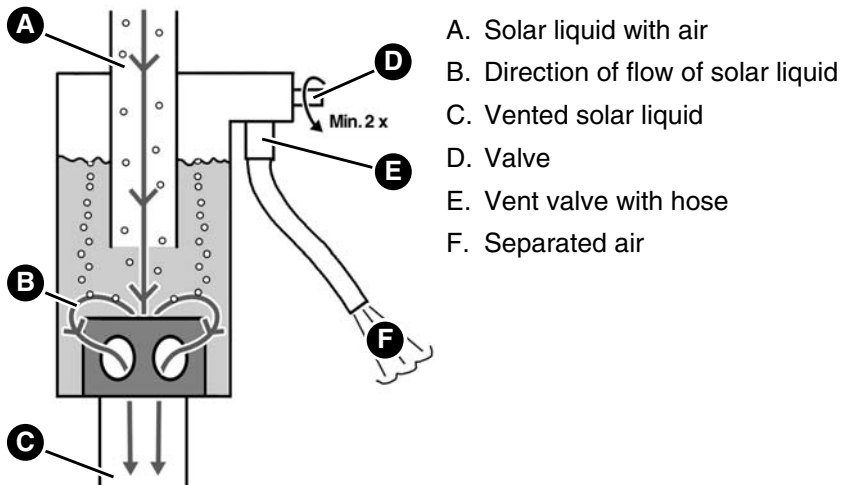

Fig. 10: Function principle of vent pot

The solar liquid flows into the vent pot from the top (A). The solar liquid hits the surface. Air bubbles are separated and rise to the top. The air collects in the upper part of the vent pot. This air can be removed from the system by manual venting.

1. Put the hose of the vent valve (E) into a collection receptacle.
2. Open valve (D).
 - The separated air escapes from the vent pot.
3. Close the valve (D) as soon as solar liquid escapes.

8 Maintenance

8.1 Maintenance intervals

When	Activity
Flow meter can no longer be read	Drain, flush and fill the system.
Circulation pump is defective	Replace the circulation pump.

8.2 Maintenance activities

8.2.1 Replace circulation pump

1. Close the shut-off at the flow meter and set the blue ball valve to 90 ° position.
2. Replace the circulation pump.
3. Open the shut-off at the flow meter and set the blue ball valve to 0 ° position.
4. In the case of pressure loss in the system, refill solar liquid and recommission the system.

9 Troubleshooting

Any malfunctions that cannot be removed by means of the measures described in this chapter may only be repaired by the manufacturer.

⇒ Observe the information in the enclosed operating instructions in the case of malfunctions of the circulation pump.

Problem	Possible reason	Repair
Noise in the system	Air in the system	Vent the system (see chapter "Venting the system")
	Pump capacity too high	Set the pump capacity to a lower speed of rotation
Noise in the circulation pump	System pressure is too low	Increase the system pressure or check the gas volume in the expansion vessel
Circulation pump does not start	Incorrect power supply	Check fuses; check for loose cable terminals
	Circulation pump blocked by deposits in the bearings	Switch to maximum speed of rotation for a short period of time Unblock the rotor by inserting a screwdriver into the groove and rotating the rotor manually
	Circulation pump polluted	Dismount and clean the circulation pump
	Circulation pump is defective	Replace the circulation pump (see chapter "Replace circulation pump")

Problem	Possible reason	Repair
No pressure in the system	Safety valve is defective	Replace the safety group assembly
	Expansion vessel not tight	Replace the expansion vessel
	Leak in the system	Contact your installer
When the system is drained, no liquid escapes via the filling and flushing units	Ball valves and/or are shut-off closed	Set the ball valves to 45 ° position and open shut-off
Other malfunctions	-	Contact the AFRISO service hotline

10 Decommissioning, disposal

Dispose of the product in compliance with all applicable directives, standards and safety regulations.

Electronic components must not be disposed of together with the normal household waste.



1. Disconnect the product from mains.
2. Dismount the product (see chapter "Mounting", reverse sequence of steps).
3. Dispose of the product.

11 Returning the device

Get in touch with us before returning your product.

12 Warranty

See our terms and conditions at www.afriso.com or your purchase contract for information on warranty.

13 Spare parts and accessories



NOTICE

DAMAGE DUE TO UNSUITABLE PARTS







- Only use genuine spare parts and accessories provided by the manufacturer.





Failure to follow these instructions can result in equipment damage.

Product

Product designation		Part no.	Figure
Solar pump assembly PrimoSol® 130-1	Measuring range 2-12 l/min / 7.5 m	77886	
Solar pump assembly PrimoSol® 130-4	Measuring range 2-12 l/min / 7.5 m	77889	

Spare parts and accessories

Product designation		Part no.	Figure
Filling and flushing unit With ball valve, two boiler filling and drain valves KFE G ³ / ₄ , compression fittings at both ends Ø 22 mm, Length 127 mm		77781	
Flow meter	Measuring range	77871	
With filling and flushing unit, ball valve, flange with union nut G1 ¹ / ₂ , connection G ³ / ₄ , length 127 mm	2-12 l/min	-	
	8-28 l/min	-	
Ball valve return (blue) With integrated adjustable gravity brake and connection for safety group assembly, thermometer in hand wheel, range 0 °C to 120 °C		77875	
Ball valve flow (red) With integrated adjustable gravity brake, thermometer in hand wheel, range 0 °C to 120 °C		77876	
Vent pot		77873	
Safety group assembly Connection for expansion vessel with connection G ³ / ₄ , solar safety valve 6 bar, pressure gauge 0/10 bar		77972	

Product designation		Part no.	Figure
<p>Connection kit for diaphragm expansion vessels (MAG)</p> <p>Suitable for safety group assembly, wall bracket, flex pipe flat-sealing (500 mm, union nuts G^{3/4} and gaskets), adapter, MAG mounting valve G^{3/4}, fastening material</p>		77904	
Flex pipe	Length	77794	
Flat-sealing for connection G ^{3/4}	500 mm		
<p>MAG mounting valve</p> <p>To separate the expansion vessel from the system, G^{3/4} female thread x G^{3/4} male thread</p>		77793	
<p>Collector tank for solar liquid</p> <p>For connection to the solar safety valve, with drain valve, volume 9 l</p>		77796	

14 Appendix

14.1 EC Declaration of Conformity

Technik für Umweltschutz		Messen. Regeln. Überwachen.	
EU – Konformitätserklärung			Formblatt FB 27 - 03
EU-Declaration of Conformity / Déclaration EU de conformité Declaración de conformidad CE / Declaração de conformidade CE			
Name und Anschrift des Herstellers: <u>AFRISO-EURO-INDEX GmbH, Lindenstr. 20, 74363 Güglingen</u> <i>Manufacturer / Fabricant / Fabricante / Nome e endereço do fabricante:</i>			
Erzeugnis: <u>Solar-Pumpengruppen / Solar pump groups</u> <i>Product / Produit / Producto / Produto:</i>			
Typenbezeichnung: <u>PrimoSol 130-1 (solar pump line), PrimoSol 130-4 (solar pump group)</u> <i>Type / Type / Tipo / Tipo:</i>			
Betriebsdaten: <u>AC 230V, 6 bar</u> <i>Techn. Details:</i>			
<i>Caractéristiques / Características / Detalhes técnicos:</i>			
Wir erklären in alleiniger Verantwortung, dass das bezeichnete Erzeugnis mit den Vorschriften folgender Europäischer Richtlinien übereinstimmt: <i>The above mentioned product meets the requirements of the following European Directives</i> <i>Le produit mentionné est conforme aux prescriptions des Directives Européennes suivantes</i> <i>El producto indicado cumple con las prescripciones de las Directivas Europeas siguientes</i> <i>O produto indicado cumpre com as prescrições das seguintes Diretivas Europeias:</i>			
Elektromagnetische Verträglichkeit (2014/30/EU)			
<i>Directive Electromagnetic Compatibility / Directive compatibilité électromagnétique / Directiva compatibilidad electromagnética / Directiva sobre compatibilidade eletromagnética</i>			
- EN 55014-1:2006/A1:2009/A2:2011, EN 55014-2:2015			
- EN 61000-3-2:2014, EN 61000-3-3:2013			
Niederspannungsrichtlinie (2014/35/EU)			
<i>Low Voltage Directive / Directive basse tension / Directiva baja tensión / Directiva sobre baixa tensão</i>			
- EN 60335-1:2012/AC:2014/A11:2014			
- EN 60335-2-51:2003/A1:2008/A2:2012, EN 62233:2008			
Ökodesign-Richtlinie (2009/125/EG) (641/2009, 622/2012)			
<i>Ecodesign Directive</i>			
- EN 16297-1:2012, EN 16297-2:2012, EN 16297-3:2012			
RoHS-Richtlinie (2011/65/EU)			
<i>RoHS Directive / Directive RoHS / Directiva RoHS / Diretiva RoHS</i>			
Unterzeichner:		<u>Dr. Aldinger, Geschäftsführer Technik</u>	
Signed / Signataire / Firmante / Assinado por:		Technical Director / Diretor Técnico	
15.11.2017			
Datum / Date / Fecha / Data		Unterschrift / Signature / Firma / Assinatura	